

Hypersen LIDAR HPS-3D160 Pro sensor

Based on Time-of-Flight technology, integrating infrared systems and laser illumination systems, the sensor generates three-dimensional point clouds and transmits the signal at high speed

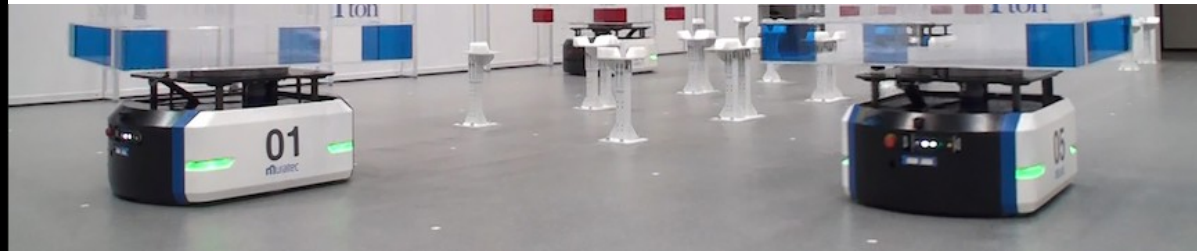

Single distributor SD Companies SRL, via Villafranca 25, Altamura (BA),
www.sdcompanies.it, produced by Hypersen Technologies Co., Made in China

LIDAR sensor HPS-3D160 Pro de

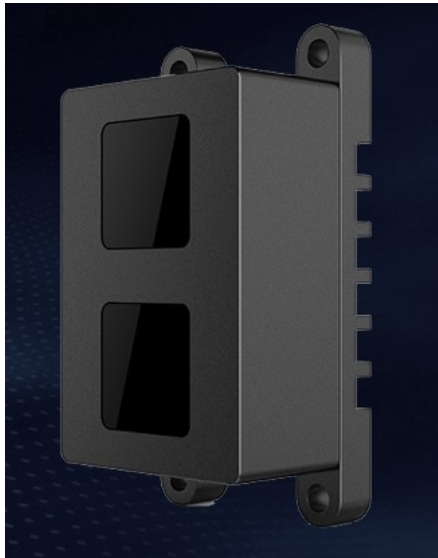

Suitable for applications in robots, AGVs, people counting, safe area protection, automated control systems, autonomous transport systems, logistics, piece control.



Single distributor SD Companies SRL, via Villafranca 25, Altamura (BA),
www.sdcompanies.it, produced by Hypersen Technologies Co., Made in China

Hypersen LIDAR HPS-3D160 Pro sensor

Integrated anti-jamming system to avoid machine block to support input from multiple sensors at the same time. 100% solid state sensor, suitable for outdoor applications (IP67) and easy to be integrated due to its small size

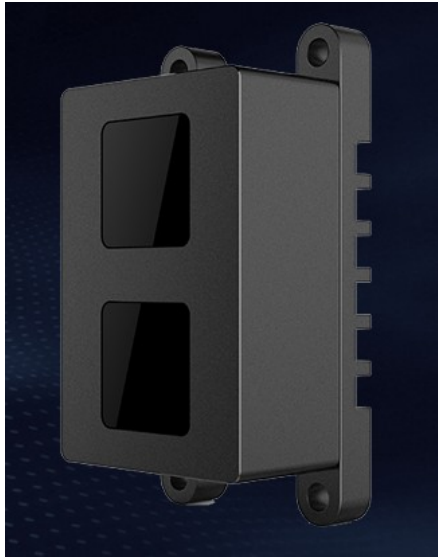

Model	HPS-3D160 Pro
Type	Solid-state
Measuring method	ToF
Resolution	160*60
Minimum resolution	1cm
FoV	76*32deg.
Frame rate	35Hz/Adjustable
Measuring range	0.25~3m @10% reflectivity 0.25~8m @90% reflectivity



Precision	±2cm
Ambient Light Immunity	80,000Lux
Communication interface	LAN, USB, USB-IO, RS-232(Slow)
Operating temperature	-10~+55°C
Power supply	12~24V
Power consumption	3~5W
Weight	110g
Size	78*40*30mm



Single distributor SD Companies SRL, via Villafranca 25, Altamura (BA),
www.sdcompanies.it, produced by Hypersen Technologies Co., Made in China

Hypersen LIDAR HPS-3D160 Pro sensor

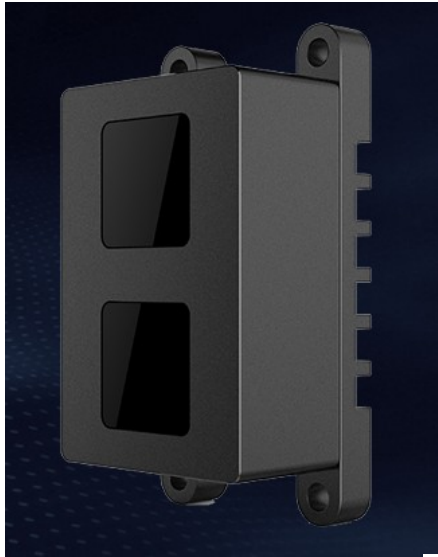

Integrated anti-jamming system to avoid machine block to support input from multiple sensors at the same time. 100% solid state sensor, suitable for outdoor applications (IP67) and easy to be integrated due to its small size

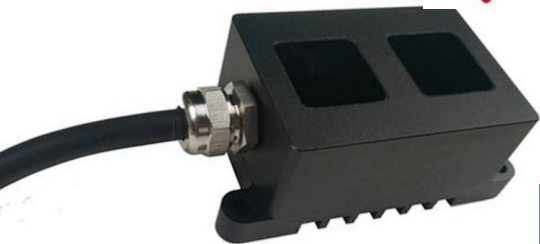
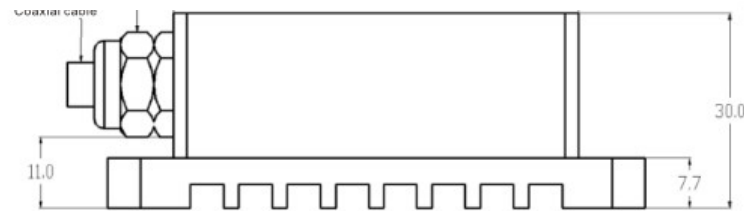
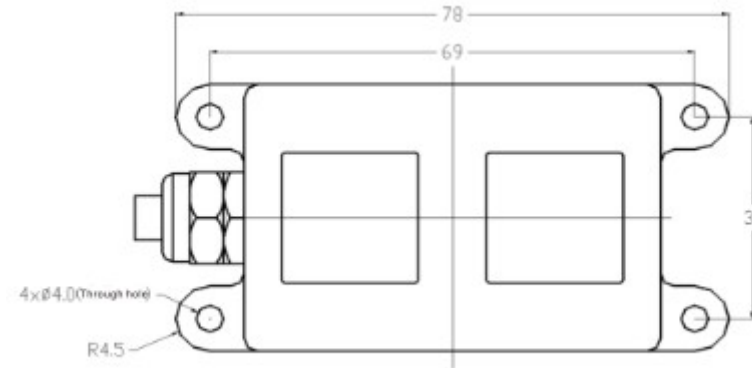

Single distributor SD Companies SRL, via Villafranca 25, Altamura (BA),
www.sdcompanies.it, produced by Hypersen Technologies Co., Made in China

Hypersen LIDAR HPS-3D160 Pro sensor

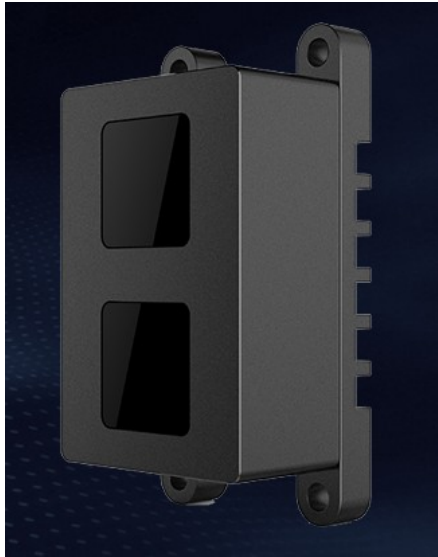

Contacts:
SD Companies SRL
Via Villafranca 25
70022 - Altamura (BA)
+ 39 3332933211
info@sdcompanies.it
PI: 08301650720

SD Companies SRL:

- Provides the product
- Integrate the device into your machines
- Develop any software for specific usage applications
- Technical assistance

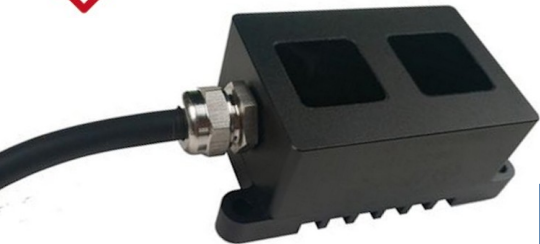

Single distributor SD Companies SRL, via Villafranca 25, Altamura (BA),
www.sdcompanies.it, produced by Hypersen Technologies Co., Made in China